



DSD-080

SEISMIC SECURITY PANEL



DESCRIPTION

DATAKOM DSD-080 Seismic Security Panel monitors seismic motions of a strong earthquake and provides relay output signals from it. Output signals are used to shut-off critical installations as natural gas and LPG systems, generators, elevators and the like.

The unit helps reducing damages of a probable earthquake. On its graphical display screen, the unit shows system status.

DSD-080 incorporates highly sensitive triple axis seismic sensors. The unit is maintenance free and capable of making self-test.

The earthquake sensing specifications of DSD-080 conforms to both ANSI Z21.80 (1981), ASCE 25-97 and TS-12884(2002) standards.

DSD-080 operates on mains with a battery backup. 24V/1.2A-h batteries are incorporated to the unit. The unit provides automatic battery charging feature. During long mains failures, if batteries get low, the unit gives audible and visible alarm.

The unit provides 5 high power relay outputs. Through the programming menu, outputs may be assigned to any function selected from a list.

FEATURES

- **Wide operating voltage range**
- **Conformal to earthquake standards**
- **Triple axis motion detection**
- **Automatic self-test**
- **Internal audible warning**
- **Internal 24V battery**
- **5 programmable relay outputs (5Amp)**
- **Visual indicators for battery status**
- **Wide operating temperature range**

Sensor Specifications

Sensor type: Triple axis polysilicon semiconductor acceleration sensors.

Sensor operating limits: ±2g.

Sensor failure limit: more than 50g.

Acceleration threshold: TS12884, ANSI Z21.80 (1981), ASCE 25-97

Detection delay: 0.5sn. maximum

Frequency range: 0.5Hz to 25Hz



COPYRIGHT NOTICE

Any unauthorized use or copying of the contents or any part of this document is prohibited.

ABOUT THIS DOCUMENT

This document describes minimum requirements and necessary steps for the successful installation of the DSD-080 family units.

Follow carefully advices given in the document. These are often good practices for the installation which reduce future issues.

For all technical queries please contact Datakom at below e-mail address:

technical.support@datakom.com.tr

REVISION HISTORY

| REVISION | DATE | WRITTEN | DESCRIPTION |
|----------|------------|---------|---------------|
| 01 | 20.12.2016 | MH | First edition |

TERMINOLOGY



CAUTION: Potential risk of injury or death.



WARNING: Potential risk of malfunction or material damage.



ATTENTION: Useful hints for the understanding of device operation.



SAFETY NOTICE

Failure to follow below instructions will result in death or serious injury



- Electrical equipment should be installed only by qualified specialist. No responsibility is assured by the manufacturer or any of its subsidiaries for any consequences resulting from the non-compliance to these instructions.

- Check the unit for cracks and damages due to transportation. Do not install damaged equipment.



- Do not open the unit. There is no serviceable parts inside.

- Fuses must be connected to phase voltage inputs, in close proximity of the unit.



- Fuses must be of fast type (FF) with a maximum rating of 6A.



- Disconnect all power before working on equipment.



- When the unit is connected to the network do not touch terminals.

- Any electrical parameter applied to the device must be in the range specified in the user manual.



- Do not try to clean the device with solvent or the like. Only clean with a dry cloth.

- Verify correct terminal connections before applying power.

- Designed for vertical wall mounting.

TABLE OF CONTENTS

Section

1. COMMISSIONING
2. INSTALLATION
 - 2.1. DIMENSIONS
 - 2.2. MECHANICAL INSTALLATION
 - 2.3. ELECTRICAL INSTALLATION
 - 2.4. INSTALLATION DIAGRAM
3. PUSHBUTTON FUNCTIONS
4. DISPLAYS
5. ALARMS
6. DEVICE CONFIGURATION
 - 6.1. ENTERING THE PROGRAM MODE
 - 6.2. CHANGING PARAMETER VALUE
 - 6.3. LIST OF PARAMETERS
 - 6.4. LIST OF FUNCTIONS
 - 6.5. RELAY FUNCTIONS
7. TEST MENU SCREEN
8. TECHNICAL SPECIFICATIONS

1. COMMISSIONING

Before installation:

- Read the user manual carefully, determine the correct connection diagram.
- Install the unit to a flat surface. A vertical surface should be preferred.
- Fix the unit to the wall through screw openings.
- Make electrical connections with plugs removed from sockets, then place plugs to their sockets. Otherwise you may destroy the socket and connector.
- Be sure that the ambient temperature will not exceed the maximum operating temperature limit.

Below conditions may damage the device:

- Incorrect connections.
- Incorrect power supply voltage.
- Overload or short circuit at relay outputs

Below conditions may cause abnormal operation:

- Power supply voltage below minimum acceptable level.
- Power supply frequency out of specified limits
- Installation on vibrating places or vibrating parts.

2. INSTALLATION

2.1. DIMENSIONS

Dimensions: 192x120x65mm (WxHYxD)

Weight: 1900g

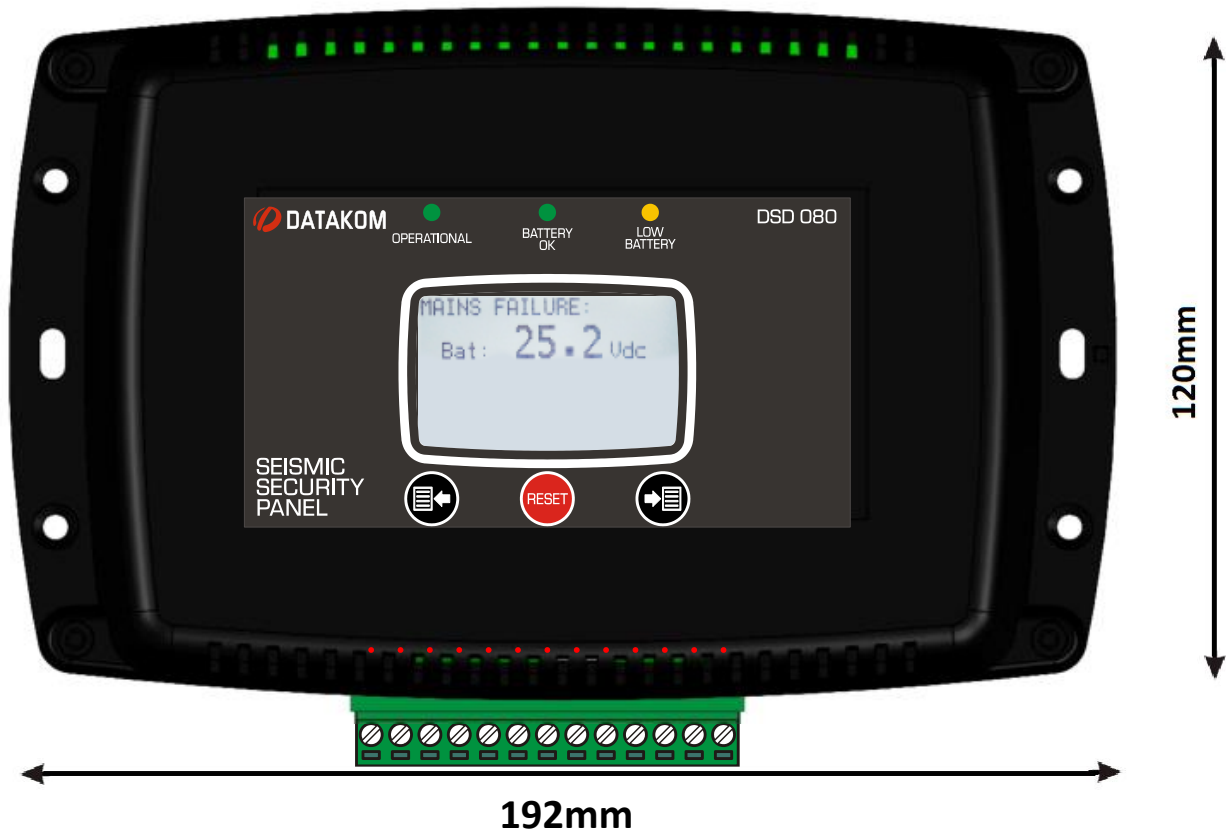

2.2 MECHANICAL INSTALLATION

The unit is designed for wall mounting. Please mount on a flat surface through screw openings.

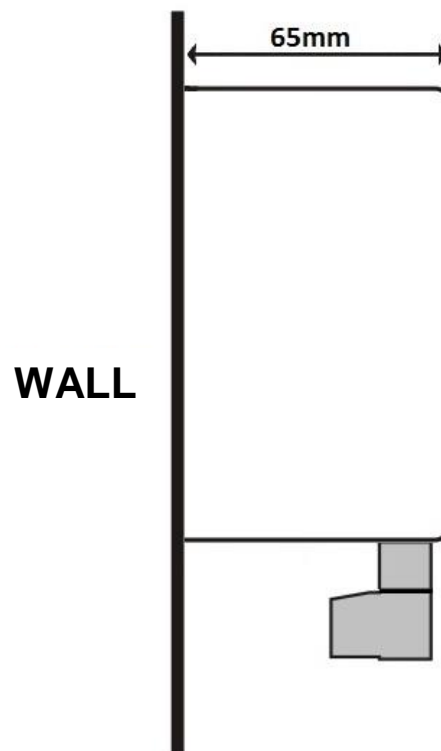
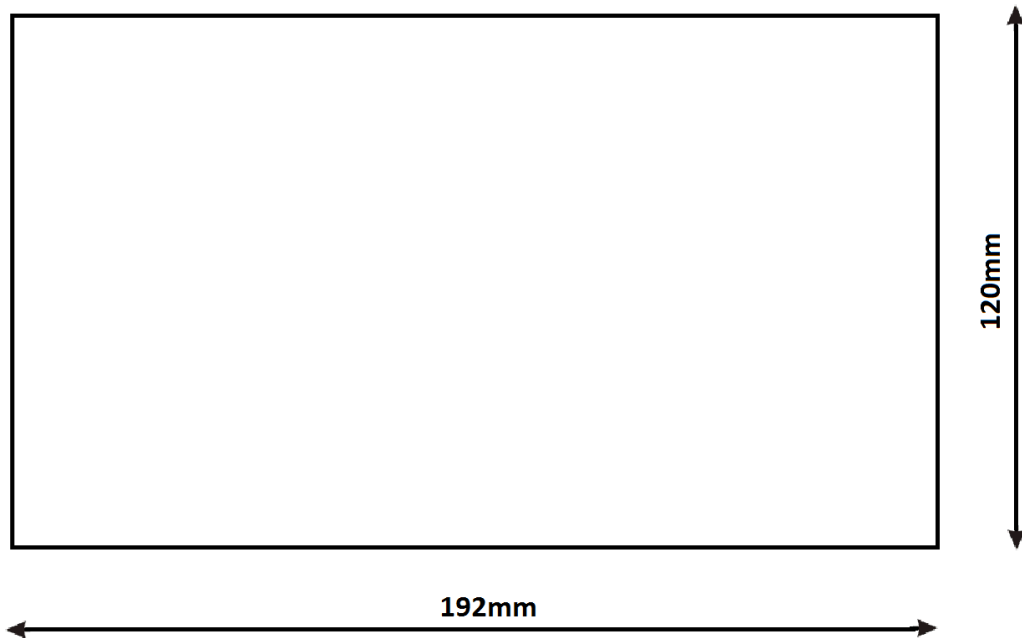

2.3 ELECTRICAL INSTALLATION



Do not install the unit close to high electromagnetic noise emitting devices like contactors, high current busbars, switchmode power supplies and the like.

Although the unit is protected against electromagnetic disturbance, excessive disturbance can affect the operation, measurement precision and data communication quality.

- **ALWAYS** remove plug connectors when inserting wires with a screwdriver.
- Fuse must be connected to phase voltage input, in close proximity of the unit.
- Fuses must be of fast type (FF) with a maximum rating of 6A.
- Use cables of appropriate temperature range.
- Use adequate cable section, at least 0.75mm² (AWG18).



Be sure that relay outputs are not overloaded.





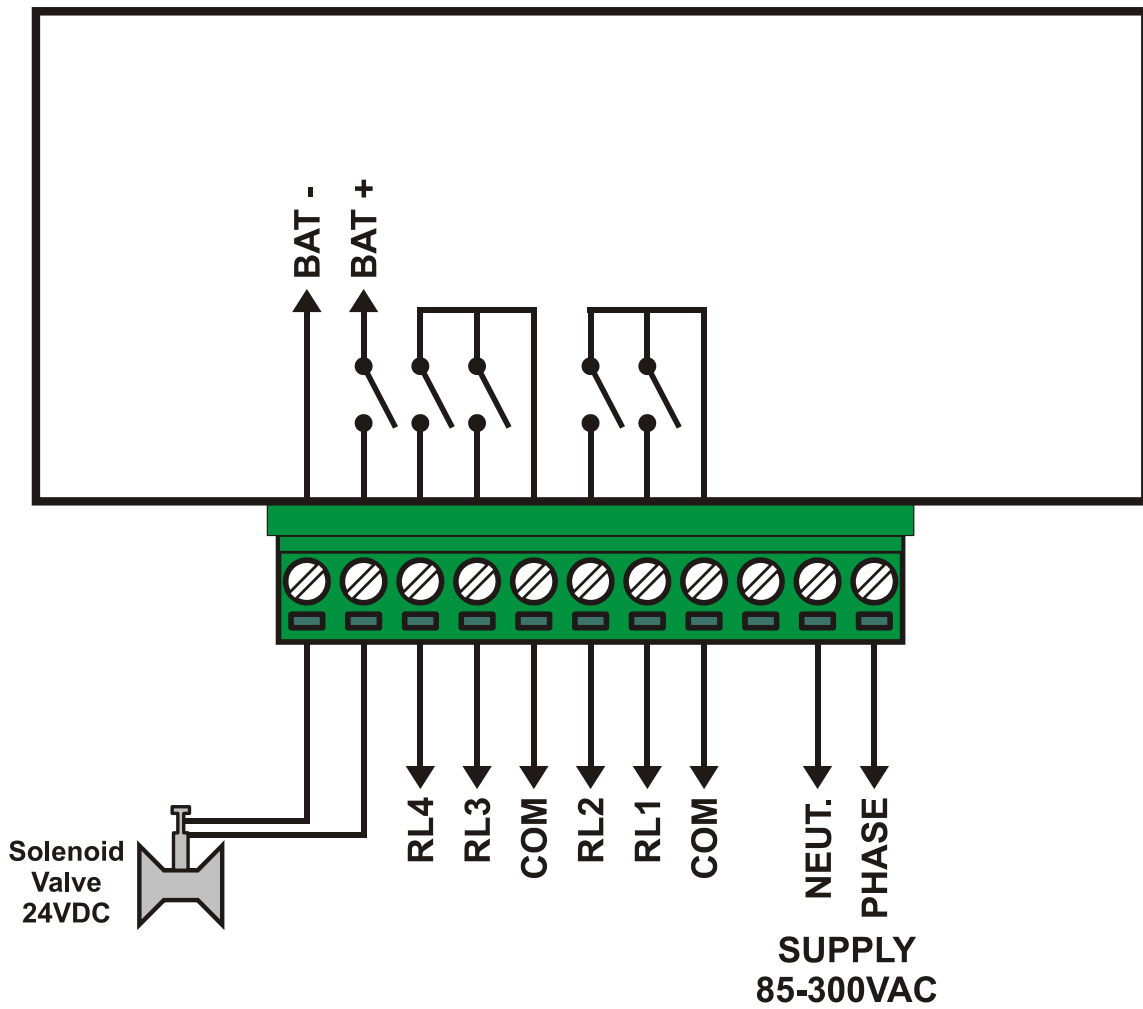

Use additional contactors when necessary.

2.4 CONNECTION DIAGRAM



3. PUSHBUTTON FUNCTIONS

Three buttons on the front panel provide access to configuration and test screens.

| BUTTON | FUNCTION |
|---|---|
|  | Used to record modifications at the programming mode. |
|  | <u>HELD PRESSED FOR 5 SECONDS:</u> Alarms and alarm relay are reset. |
|  | Used to navigate between menus. <u>Programming mode:</u> Increase related value. |
|  | Used to navigate between menus. <u>Programming mode:</u> Decrease related value. |
|  | <u>HELD PRESSED TOGETHER FOR 3 SECONDS:</u> Enters the programming mode. If already in programming mode, then exits programming mode. |
|  | <u>HELD PRESSED TOGETHER FOR 3 SECONDS:</u> If both pushbuttons are held pressed during 3 seconds, then enters Test mode. |

4. DISPLAYS

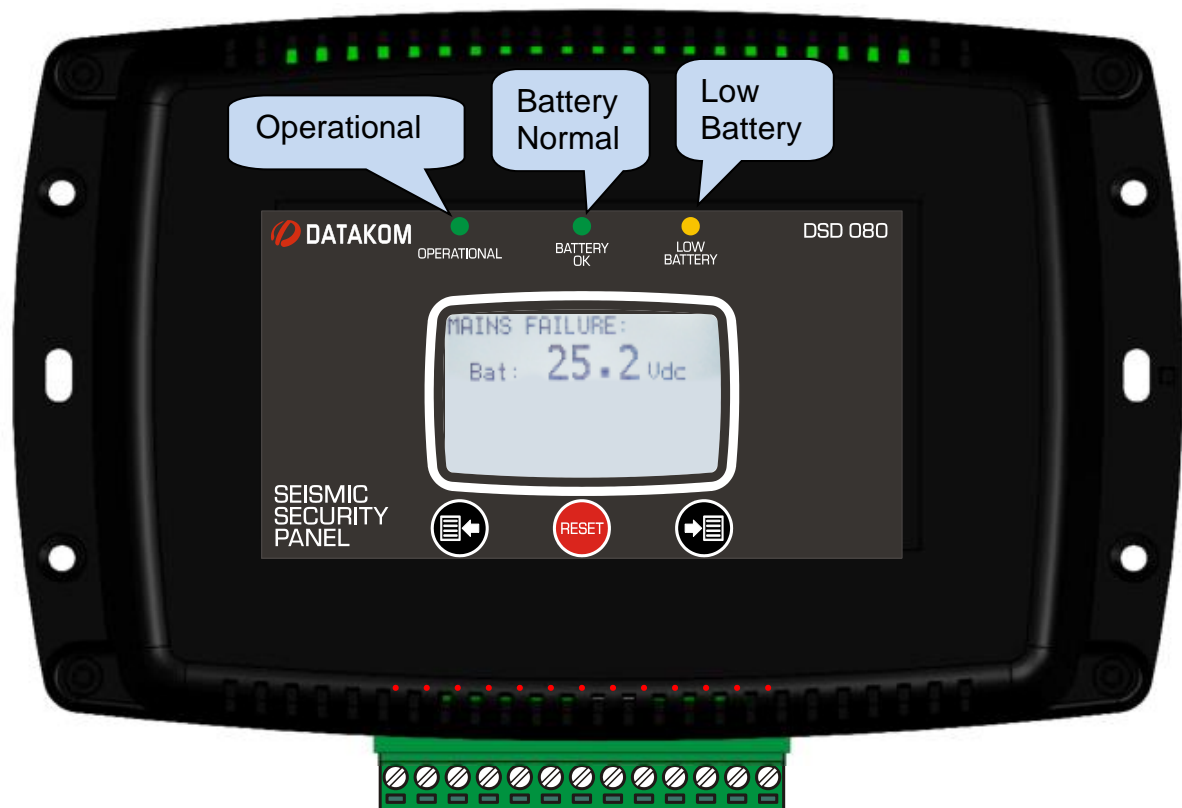

OPERATIONAL LED: Indicates that the unit is operating normally.

BATTERY NORMAL LED: Indicates that the battery voltage is above the “**Low Battery Voltage**” parameter.

LOW BATTERY LED: Indicates that the battery voltage is below the “**Low Battery Voltage**” parameter.

5. ALARMS

The unit provides two different alarm levels for “Weak Motion” and “Strong Motion”.

The unit has a closed circuit detector at the solenoid relay output. If the solenoid connection is broken, then a “no solenoid” alarm will occur.

Additionally a “Low Battery” alarm is provided.

Any of the above alarms may be assigned to any relay output. However the Solenoid output can be only assigned as “Strong Motion” alarm.

When any alarm occurs, related relay outputs become active and the unit gives an audible alarm.



By depressing the RESET pushbutton, alarms are reset and relays return to their initial position.

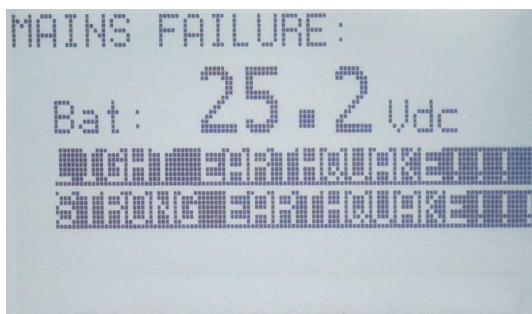

| ALARM MESSAGE | DESCRIPTION |
|----------------------|--|
| LOW BATTERY | Occurs when the battery voltage is below the “Low Battery Voltage” parameter. |
| WEAK MOTION | Occurs when the measured acceleration is over the user-defined threshold for the weak motion. |
| STRONG MOTION | Occurs when the measured acceleration is over the threshold for the strong motion. This threshold is defined by international standards and is not adjustable. |
| NO SOLENOID | Occurs when there is no connection at solenoid output, or when the conductor wires are broken. |



6. DEVICE CONFIGURATION

6.1 ENTERING THE PROGRAM MODE

In order to enter the program mode, please hold pressed  and  pushbuttons during 3 seconds. When program mode is entered, the PROGRAM MENU will come to the screen.

Using  or  pushbuttons, program parameters may be scanned.





Modified parameters are saved to a non-volatile memory and are not affected by energy failures.



If no button is pressed during 1 minute, the unit will automatically exit the program mode.

6.2 CHANGING PARAMETER VALUE

In program mode, the required parameter is selected using  or  pushbuttons. By depressing the  pushbutton the parameter modification is enabled.

Using  and  pushbuttons, the parameter is adjusted to the desired function and the new value is saved by depressing the  pushbutton.

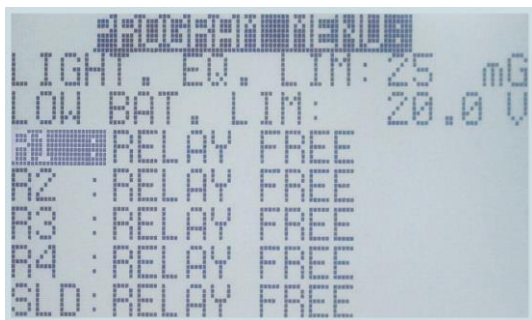

6.3 LIST OF PARAMETERS

| SCREEN | DESCRIPTION | MIN | MAX |
|-----------------|---|------|------|
| WEAK MOT. LEVEL | WEAK MOTION LEVEL This parameter defines the “weak motion” alarm threshold. When the unit detects an acceleration above this level, it will give a weak motion alarm. | 25mg | 75mg |
| DUSUK AKÜ SEV. | LOW BATTERY VOLTAGE If the measured internal battery voltage is below this parameter, then a “low battery” alarm will occur. | 18V | 26V |
| R1, R2, R3, R4 | RELAY DEFINITIONS User defined function settings of relays | | |
| SLD | SOLENOID OUTPUT This parameter defines the characteristics of the solenoid output. | | |

6.4 LIST OF FUNCTIONS

Relay and solenoid outputs of the unit may be adjusted to various functions.



| Fonksiyon | Açıklama |
|------------------------|--|
| RELAY OPEN | Output is always passive. |
| LOW BATTERY | Output closed when battery is low. |
| WEAK MOTION | Output closed during a weak motion. |
| WEAK MOTION LATCHED | Output closed during a weak motion. Remains closed until manually reset. |
| WEAK MOTION SOLENOID | Output closed every 10 seconds when a weak motion is detected. Continues operation until a manual reset. |
| WEAK MOTION SIGNAL | Output closed every second when a weak motion is detected. Continues operation until a manual reset. |
| STRONG MOTION | Output closed during a strong motion. |
| STRONG MOTION LATCHED | Output closed during a strong motion. Remains closed until manually reset. |
| STRONG MOTION SOLENOID | Output closed every 10 seconds when a strong motion is detected. Continues operation until a manual reset. |
| STRONG MOTION SIGNAL | Output closed every second when a strong motion is detected. Continues operation until a manual reset. |

7. TEST MENU SCREEN

The unit provides a test menu in order to test relay outputs and the audible alarm.

In order to enter the test menu screen, the unit is set to program mode and pushbuttons are held pressed together during 3 seconds.



The desired function is selected using  or  pushbuttons and activated using  pushbutton.

Relay outputs, solenoid output and the audible alarm may be tested in this menu.

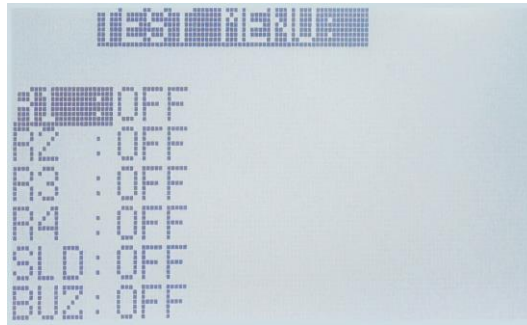

In order to exit test menu, please hold pressed   pushbuttons during 3 seconds.

8. TECHNICAL SPECIFICATIONS

| | |
|-------------------------------------|--|
| Operating voltage: | 85 to 305VAC |
| Supply power: | 4W maximum. |
| Battery charge voltage: | 27.5V (+/-0.2V) |
| Battery charge current: | 100mA maximum |
| Low battery voltage limit: | 22V. (+/- 0.3V) |
| Current drain from battery: | 15mA. max from 24VDC (All relays passive) Additional 6mA for each energized relay. |
| Battery capacity: | 24VDC, 1.2A-h |
| Operation from battery: | >24 hours (typically 72 hours) |
| Self test: | At power-on and reset. |
| Switching: | 5 relay outputs. (5A / 30VDC / 250VAC) |
| Audible warning: | 85dB/1m buzzer. |
| Operating temperature range: | -10 to +70 °C. |
| Relative humidity: | 10% to 90% arası (non-condensing) |
| Weight: | 1900 grams (approximative) |
| Dimensions: | 192x120x65mm (WxHxD) |